

Power			
Fig	Aresti	K	
1 D	5.3.1.1	18	46
	9.2.2.4	11	
	9.1.1.1	6	
	9.9.5.3	11	
2 E	7.4.3.1	14	33
	9.9.8.3	13	
	9.1.3.3	6	
3 Add.	8.8.1.1	18	6
	9.1.5.1	2	
	9.1.1.1	6	
4 H	8.6.1.4	12	44
	9.12.1.4	7	
	9.1.5.4	8	
	9.2.3.6	12	
	9.4.3.2	5	
5 I	8.4.17.2	11	36
	9.1.2.5	11	
	9.8.2.1	5	
	9.2.4.4	9	
6 C	5.2.1.1	17	42
	9.4.1.3	12	
	9.10.5.3	13	
7 A	7.2.1.1	6	50
	9.1.3.8	12	
	9.1.3.4	8	
	9.9.3.4	11	
	9.9.8.4	13	
8 Add.	7.5.7.4	15	6
	9.1.2.2	6	
	9.1.3.2	4	
9 B	8.8.7.2	21	61
	9.10.1.3	17	
	9.1.5.2	4	
	9.10.6.3	19	
10 Add.	8.8.2.1	19	6
	9.1.5.1	2	
	9.1.1.1	6	
11 F	8.6.5.3	16	50
	9.1.3.6	10	
	9.8.3.2	7	
	9.10.1.2	17	
12 Add.	8.8.1.1	18	6
	9.1.5.2	4	
13 G	7.4.1.4	11	22
	9.4.3.4	11	
14 J	7.8.3.4	19	55
	9.2.3.4	9	
	9.2.2.6	14	
	9.4.2.4	13	
Total K = 463			

A

Verified
 July 1.
 21.8.24
 8:00

Proposal "A" LUX Pilot
 A/C

Mokre, Zamość, POLAND 15-25 Aug. 24		Form B
Pilot ID	CIVA Unlimited Programme4	
		Flight #

← wind/vent

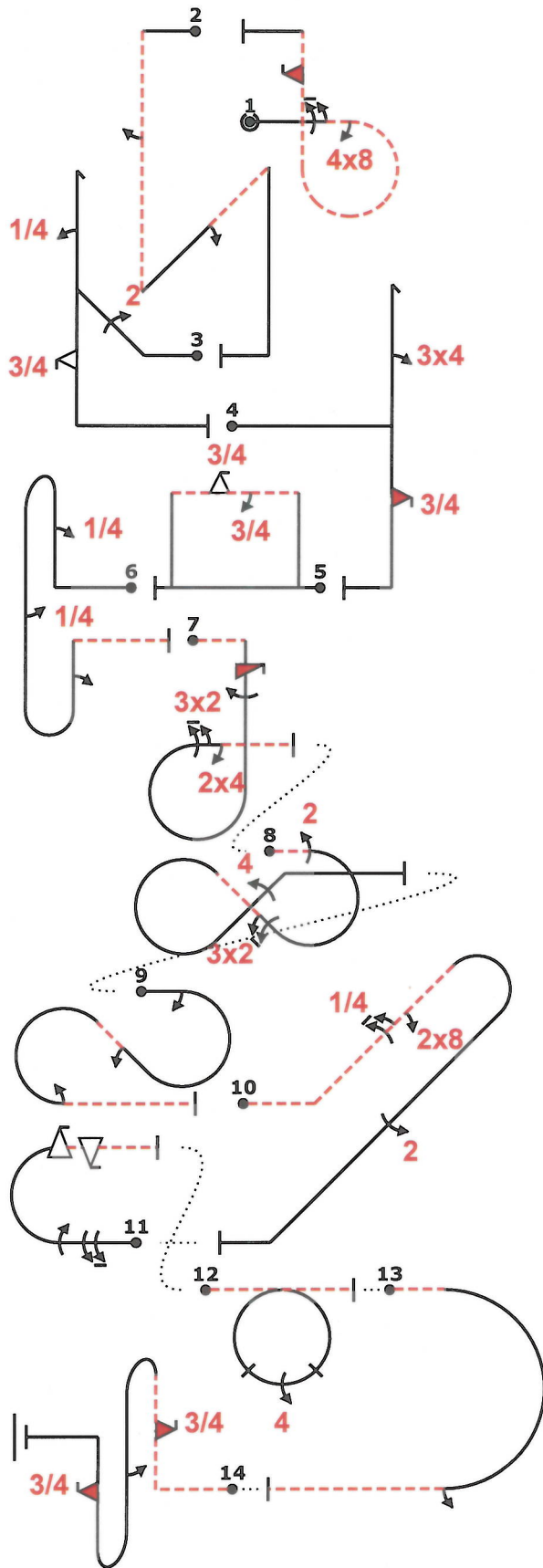

Power		
Fig	Aresti	K
1 F	8.6.5.3	16
	9.1.3.6	10
	9.8.3.2	7
	9.10.1.2	17
2 Add.	1.3.16.3	21
	9.1.5.2	4
	9.1.2.2	6
3 D	5.3.1.1	18
	9.2.2.4	11
	9.1.1.1	6
	9.9.5.3	11
4 C	5.2.1.1	17
	9.4.1.3	12
	9.10.5.3	13
5 E	7.4.3.1	14
	9.9.8.3	13
	9.1.3.3	6
6 Add.	8.8.1.1	18
	9.1.1.1	6
	9.1.5.1	2
	9.1.1.2	8
7 H	8.6.1.4	12
	9.12.1.4	7
	9.1.5.4	8
	9.2.3.6	12
	9.4.3.2	5
8 J	7.8.3.4	19
	9.2.3.4	9
	9.2.2.6	14
	9.4.2.4	13
9 Add.	7.5.8.3	15
	9.1.3.2	4
	9.1.2.2	6
	9.1.3.2	4
10 I	8.4.17.2	11
	9.1.2.5	11
	9.8.2.1	5
	9.2.4.4	9
11 A	7.2.1.1	6
	9.1.3.8	12
	9.1.3.4	8
	9.9.3.4	11
	9.9.8.4	13
12 G	7.4.1.4	11
	9.4.3.4	11
13 Add.	7.2.2.4	7
	9.1.3.2	4
14 B	8.8.7.2	21
	9.10.1.3	17
	9.1.5.2	4
	9.10.6.3	19
Total K = 463		

B

Verified
 Fry Pres.
 21.8.24
 8:00

Proposal "B" ROU
 Pilot
 A/C

Mokre/Zamość, POLAND 15-25 Aug. 24		Form B
Pilot ID	CIVA Unlimited Programme4	
	Flight #	

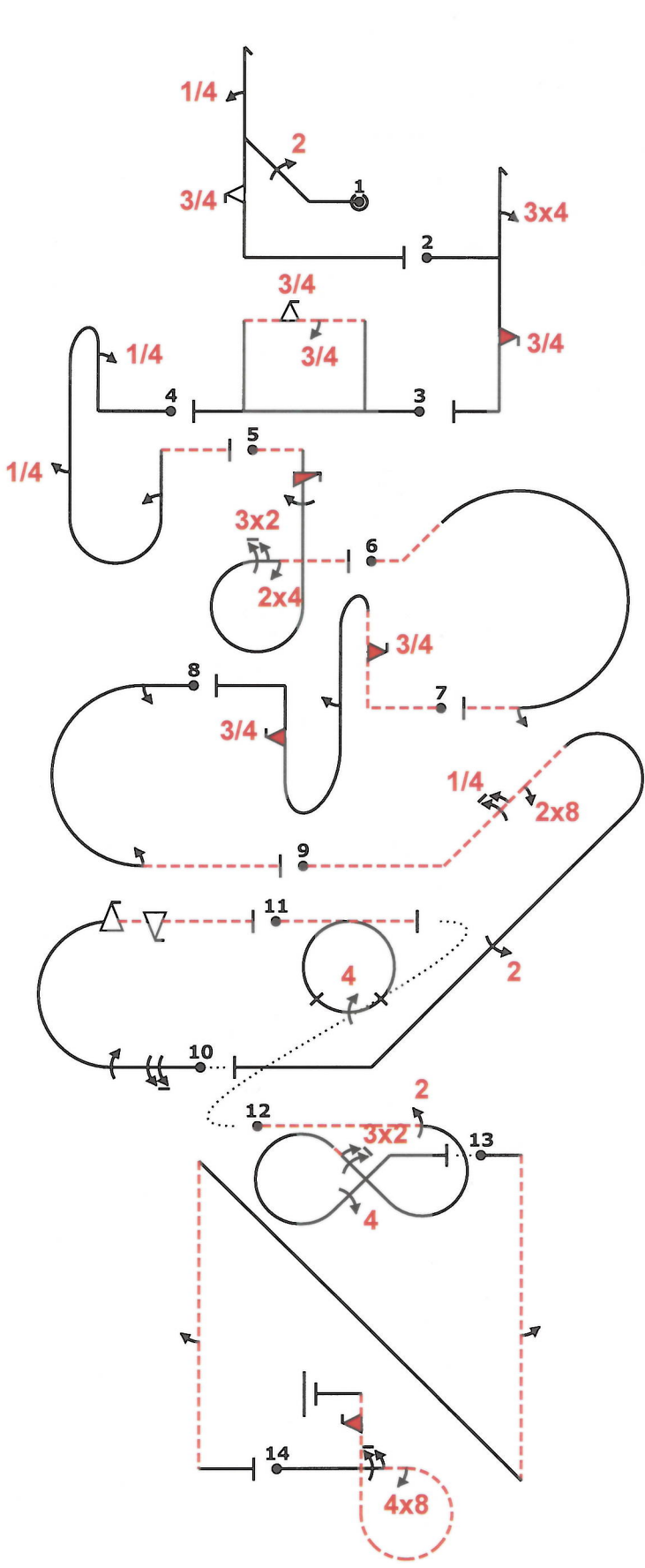

Power		
Fig	Aresti	K
1 D	5.3.1.1	13
	9.2.2.4	11
	9.1.1.1	6
	9.9.5.3	11
2 C	5.2.1.1	17
	9.4.1.3	12
	9.10.5.3	13
3 E	7.4.3.1	14
	9.9.8.3	13
	9.1.3.3	6
4 Add.	8.8.1.1	18
	9.1.1.1	6
	9.1.5.1	2
	9.1.1.2	8
5 H	8.6.1.4	12
	9.12.1.4	7
	9.1.5.4	8
	9.2.3.6	12
	9.4.3.2	5
6 Add.	8.5.3.2	11
	9.1.3.2	4
7 B	8.8.7.2	21
	9.10.1.3	17
	9.1.5.2	4
	9.10.6.3	19
8 Add.	7.2.4.3	6
	9.1.3.2	4
	9.1.3.2	4
9 I	8.4.17.2	11
	9.1.2.5	11
	9.8.2.1	5
	9.2.4.4	9
10 A	7.2.1.1	6
	9.1.3.8	12
	9.1.3.4	8
	9.9.3.4	11
	9.9.8.4	13
11 G	7.4.1.4	11
	9.4.3.4	11
12 J	7.8.3.4	19
	9.2.3.4	9
	9.2.2.6	14
	9.4.2.4	13
13 Add.	1.3.13.3	23
	9.1.5.2	4
	9.1.5.2	4
14 F	8.6.5.3	16
	9.1.3.6	10
	9.8.3.2	7
	9.10.1.2	17
Total K = 463		

Verified
 Joz P.
 21.8.24
 8:05

Proposal "C" ROU
 Pilot
 A/C

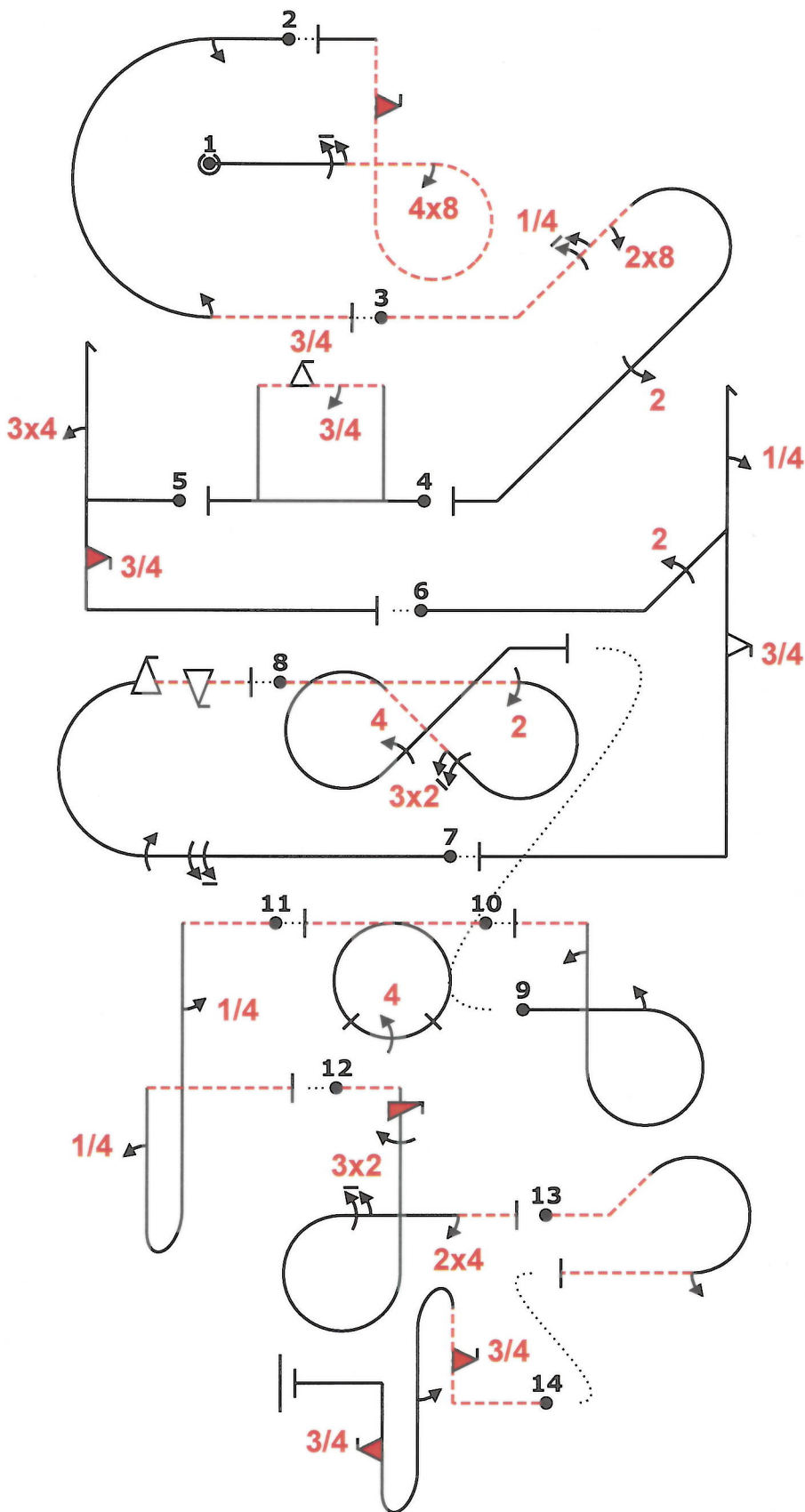
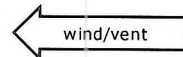

Power			
Fig	Aresti	K	
1 F	8.6.5.3	16	50
	9.1.3.6	10	
	9.8.3.2	7	
	9.10.1.2	17	
2 Add.	7.2.4.3	6	6
	9.1.3.2	4	
	9.1.3.2	4	
3 I	8.4.17.2	11	36
	9.1.2.5	11	
	9.8.2.1	5	
	9.2.4.4	9	
4 E	7.4.3.1	14	33
	9.9.8.3	13	
	9.1.3.3	6	
5 C	5.2.1.1	17	42
	9.4.1.3	12	
	9.10.5.3	13	
6 D	5.3.1.1	18	46
	9.2.2.4	11	
	9.1.1.1	6	
	9.9.5.3	11	
7 A	7.2.1.1	6	50
	9.1.3.8	12	
	9.1.3.4	8	
	9.9.3.4	11	
	9.9.8.4	13	
8 J	7.8.3.4	19	55
	9.2.3.4	9	
	9.2.2.6	14	
	9.4.2.4	13	
9 Add.	8.6.7.3	12	6
	9.1.3.2	4	
	9.1.1.2	8	
10 G	7.4.1.4	11	22
	9.4.3.4	11	
11 Add.	8.4.1.4	13	6
	9.1.5.1	2	
	9.1.1.1	6	
12 H	8.6.1.4	12	44
	9.12.1.4	7	
	9.1.5.4	8	
	9.2.3.6	12	
	9.4.3.2	5	
13 Add.	8.5.3.2	11	6
	9.1.3.2	4	
14 B	8.8.7.2	21	61
	9.10.1.3	17	
	9.1.5.2	4	
	9.10.6.3	19	
Total K = 463			

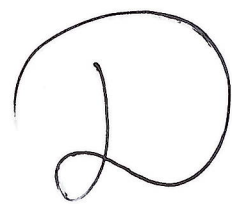

Verified
 Jay Pres.
 21.8.24
 8:05

Proposal "D" USA
 Pilot
 A/C

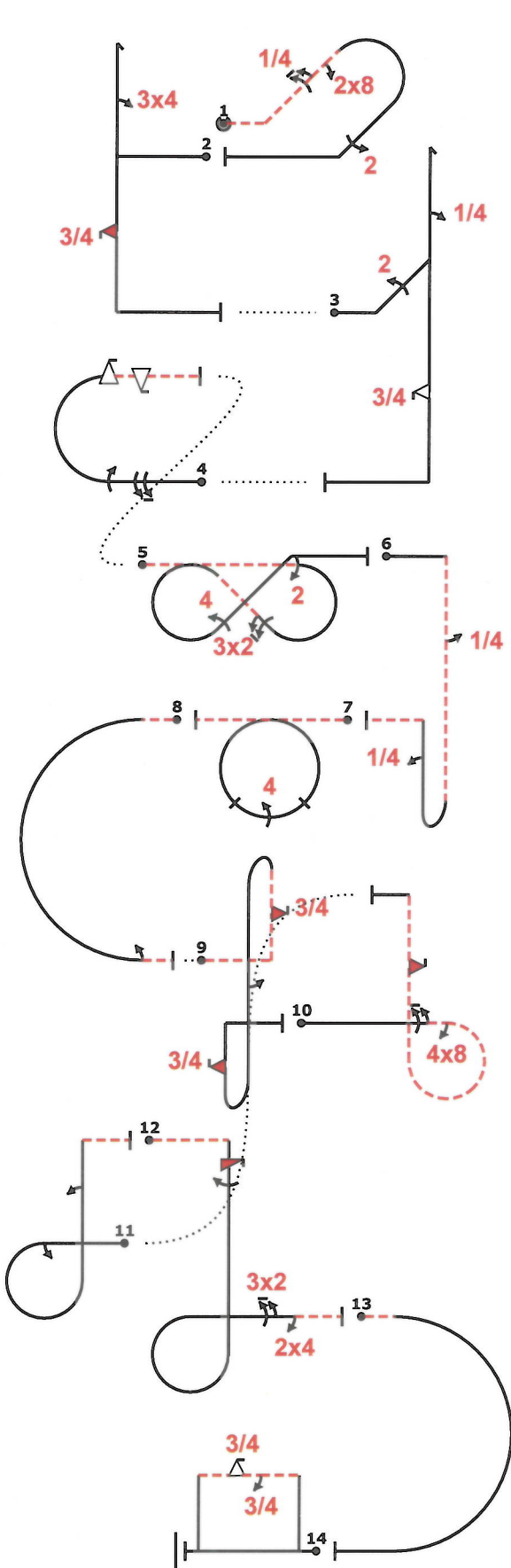

← wind/vent

Power		
Fig	Aresti	K
1	8.4.17.2	11
	9.1.2.5	11
	9.8.2.1	5
	9.2.4.4	9
2	5.2.1.1	17
	9.4.1.3	12
	9.10.5.3	13
3	5.3.1.1	18
	9.2.2.4	11
	9.1.1.1	6
	9.9.5.3	11
4	7.2.1.1	6
	9.1.3.8	12
	9.1.3.4	8
	9.9.3.4	11
	9.9.8.4	13
5	7.8.3.4	19
	9.2.3.4	9
	9.2.2.6	14
	9.4.2.4	13
6	8.4.4.3	14
	9.1.5.1	2
	9.1.1.1	6
7	7.4.1.4	11
	9.4.3.4	11
8	7.2.2.4	7
	9.1.3.2	4
9	8.8.7.2	21
	9.10.1.3	17
	9.1.5.2	4
	9.10.6.3	19
10	8.6.5.3	16
	9.1.3.6	10
	9.8.3.2	7
	9.10.1.2	17
11	8.6.7.3	12
	9.1.3.2	4
	9.1.1.2	8
12	8.6.1.4	12
	9.12.1.4	7
	9.1.5.4	8
	9.2.3.6	12
	9.4.3.2	5
13	7.2.1.4	6
	Add.	6
14	7.4.3.1	14
	9.9.8.3	13
	9.1.3.3	6
Total K = 463		

E

Verified
July Pres.
21.8.24
8:10

Proposal "E" USA
Pilot
A/C



 wind/vent

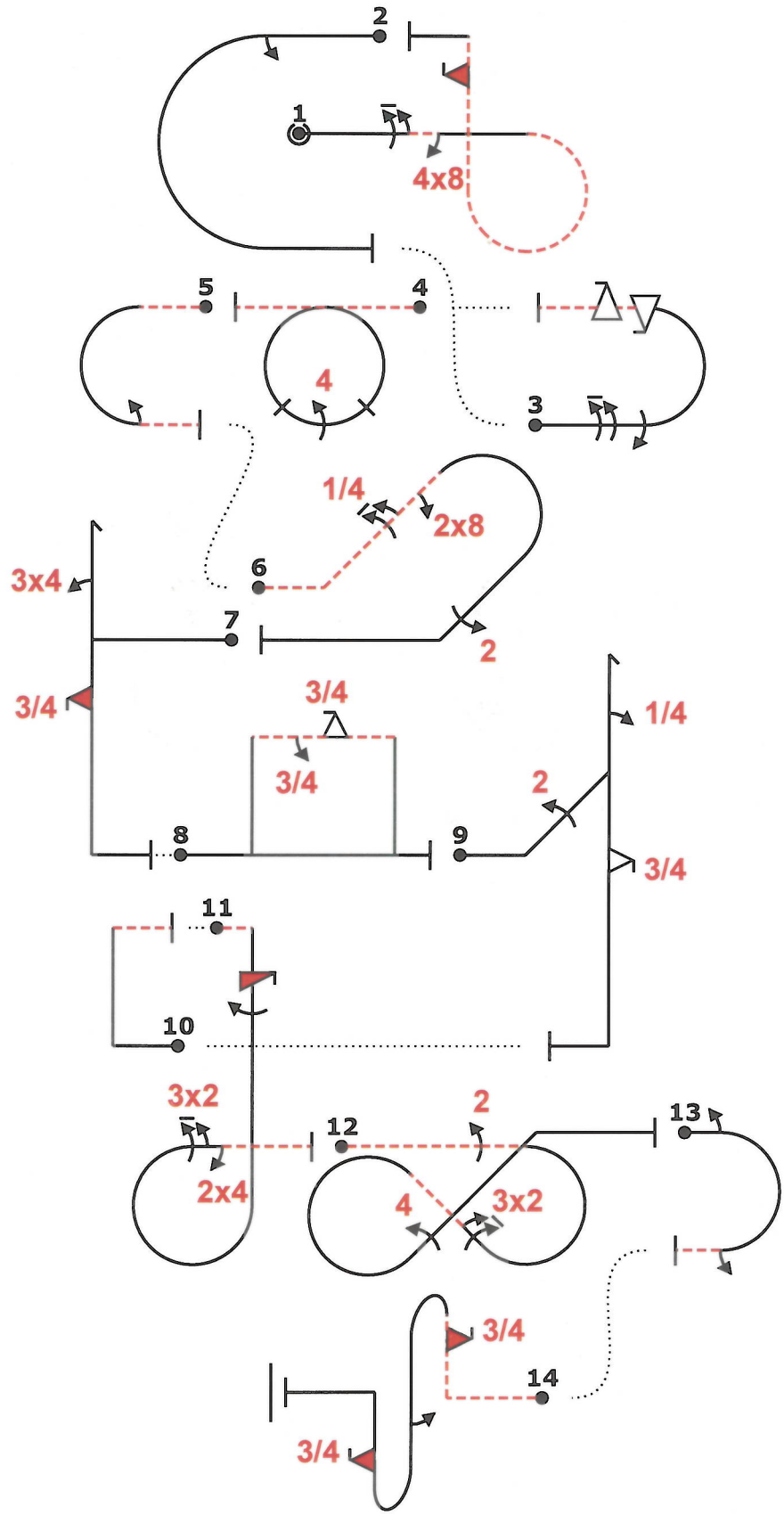

Power			
Fig	Aresti	K	
1 F	8.6.5.3	16	50
	9.1.3.6	10	
	9.8.3.2	7	
	9.10.1.2	17	
2 Add.	7.2.3.3	6	6
	9.1.3.2	4	
3 A	7.2.1.1	6	50
	9.1.3.8	12	
	9.1.3.4	8	
	9.9.3.4	11	
	9.9.8.4	13	
4 G	7.4.1.4	11	22
	9.4.3.4	11	
5 Add.	7.2.2.4	7	6
	9.1.3.2	4	
6 I	8.4.17.2	11	36
	9.1.2.5	11	
	9.8.2.1	5	
	9.2.4.4	9	
7 C	5.2.1.1	17	42
	9.4.1.3	12	
	9.10.5.3	13	
8 E	7.4.3.1	14	33
	9.9.8.3	13	
	9.1.3.3	6	
9 D	5.3.1.1	18	46
	9.2.2.4	11	
	9.1.1.1	6	
	9.9.5.3	11	
10 Add.	1.1.7.1	9	6
11 H	8.6.1.4	12	44
	9.12.1.4	7	
	9.1.5.4	8	
	9.2.3.6	12	
	9.4.3.2	5	
12 J	7.8.3.4	19	55
	9.2.3.4	9	
	9.2.2.6	14	
	9.4.2.4	13	
13 Add.	7.2.4.3	6	6
	9.1.3.2	4	
	9.1.3.2	4	
14 B	8.8.7.2	21	61
	9.10.1.3	17	
	9.1.5.2	4	
	9.10.6.3	19	
Total K = 463			

F

Verified.
 Jerry Bris.
 21.8.24
 8:10



Proposal "F" POL Pilot
 A/C

Mokre/Zamość, POLAND 15-25 Aug. 24		Form B
Pilot ID	CIVA Unlimited Programme4	
		Flight #

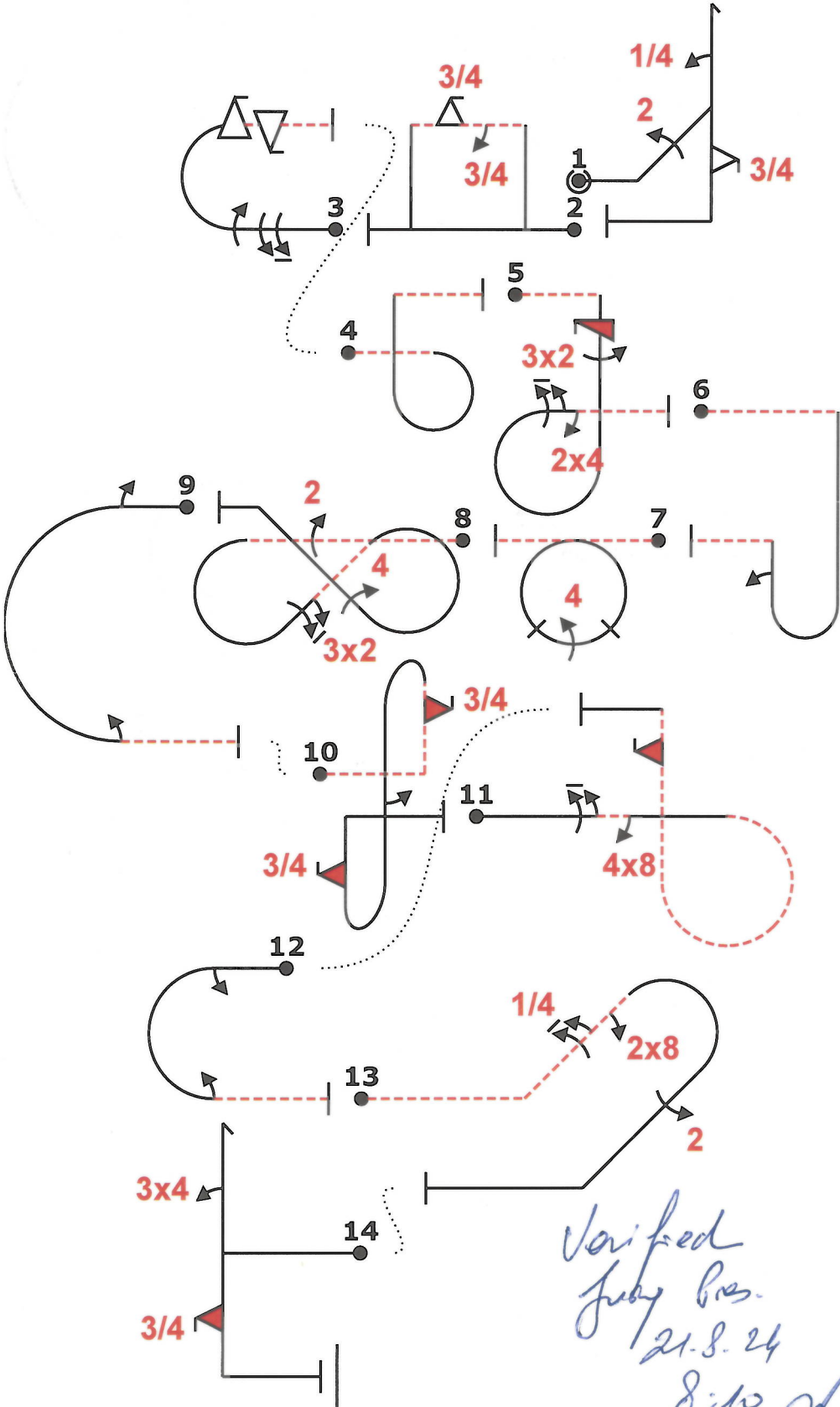
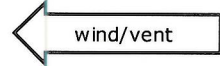

Power			
Fig	Aresti	K	
1 D	5.3.1.1	18	46
	9.2.2.4	11	
	9.1.1.1	6	
	9.9.5.3	11	
2 E	7.4.3.1	14	33
	9.9.8.3	13	
	9.1.3.3	6	
3 A	7.2.1.1	6	50
	9.1.3.8	12	
	9.1.3.4	8	
	9.9.3.4	11	
	9.9.8.4	13	
4 Add.	8.6.5.4	12	6
5 H	8.6.1.4	12	44
	9.12.1.4	7	
	9.1.5.4	8	
	9.2.3.6	12	
	9.4.3.2	5	
6 Add.	8.4.1.4	13	6
7 G	7.4.1.4	11	22
	9.4.3.4	11	
8 J	7.8.3.4	19	55
	9.2.3.4	9	
	9.2.2.6	14	
	9.4.2.4	13	
9 Add.	7.2.4.3	6	6
10 B	8.8.7.2	21	61
	9.10.1.3	17	
	9.1.5.2	4	
	9.10.6.3	19	
11 F	8.6.5.3	16	50
	9.1.3.6	10	
	9.8.3.2	7	
	9.10.1.2	17	
12 Add.	7.2.4.3	6	6
13 I	9.1.3.2	4	36
	9.1.3.2	4	
	8.4.17.2	11	
	9.1.2.5	11	
14 C	9.8.2.1	5	42
	9.2.4.4	9	
	5.2.1.1	17	
	9.4.1.3	12	
	9.10.5.3	13	
Total K = 463			

G

Verified
 July Bros.
 21.8.24
 8:10

Proposal "G" ESP
 Pilot
 A/C

← wind/vent

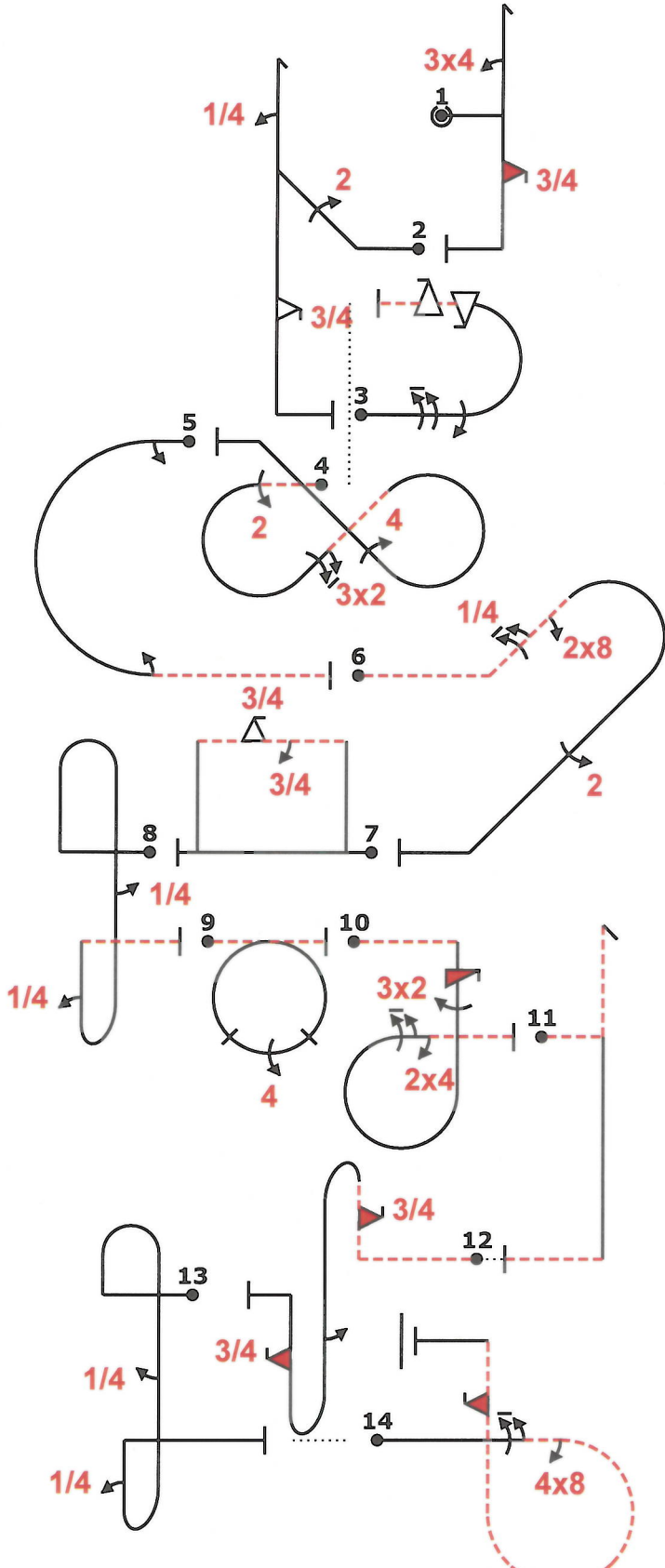

Power			
Fig	Aresti	K	
1 C	5.2.1.1	17	42
	9.4.1.3	12	
	9.10.5.3	13	
2 D	5.3.1.1	18	46
	9.2.2.4	11	
	9.1.1.1	6	
	9.9.5.3	11	
3 A	7.2.1.1	6	50
	9.1.3.8	12	
	9.1.3.4	8	
	9.9.3.4	11	
	9.9.8.4	13	
4 J	7.8.3.4	19	55
	9.2.3.4	9	
	9.2.2.6	14	
	9.4.2.4	13	
5 Add.	7.2.4.3	6	6
	9.1.3.2	4	
	9.1.3.2	4	
6 I	8.4.17.2	11	36
	9.1.2.5	11	
	9.8.2.1	5	
	9.2.4.4	9	
7 E	7.4.3.1	14	33
	9.9.8.3	13	
	9.1.3.3	6	
8 Add.	8.8.1.1	18	6
	9.1.5.1	2	
	9.1.1.1	6	
9 G	7.4.1.4	11	22
	9.4.3.4	11	
10 H	8.6.1.4	12	44
	9.12.1.4	7	
	9.1.5.4	8	
	9.2.3.6	12	
	9.4.3.2	5	
11 Add.	5.2.1.2	23	6
12 B	8.8.7.2	21	61
	9.10.1.3	17	
	9.1.5.2	4	
	9.10.6.3	19	
13 Add.	8.8.2.1	19	6
	9.1.5.1	2	
	9.1.1.1	6	
14 F	8.6.5.3	16	50
	9.1.3.6	10	
	9.8.3.2	7	
	9.10.1.2	17	
Total K = 463			

H

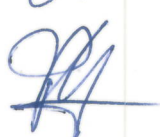
Verified
 Jury President.
 21.8.24
 8:12

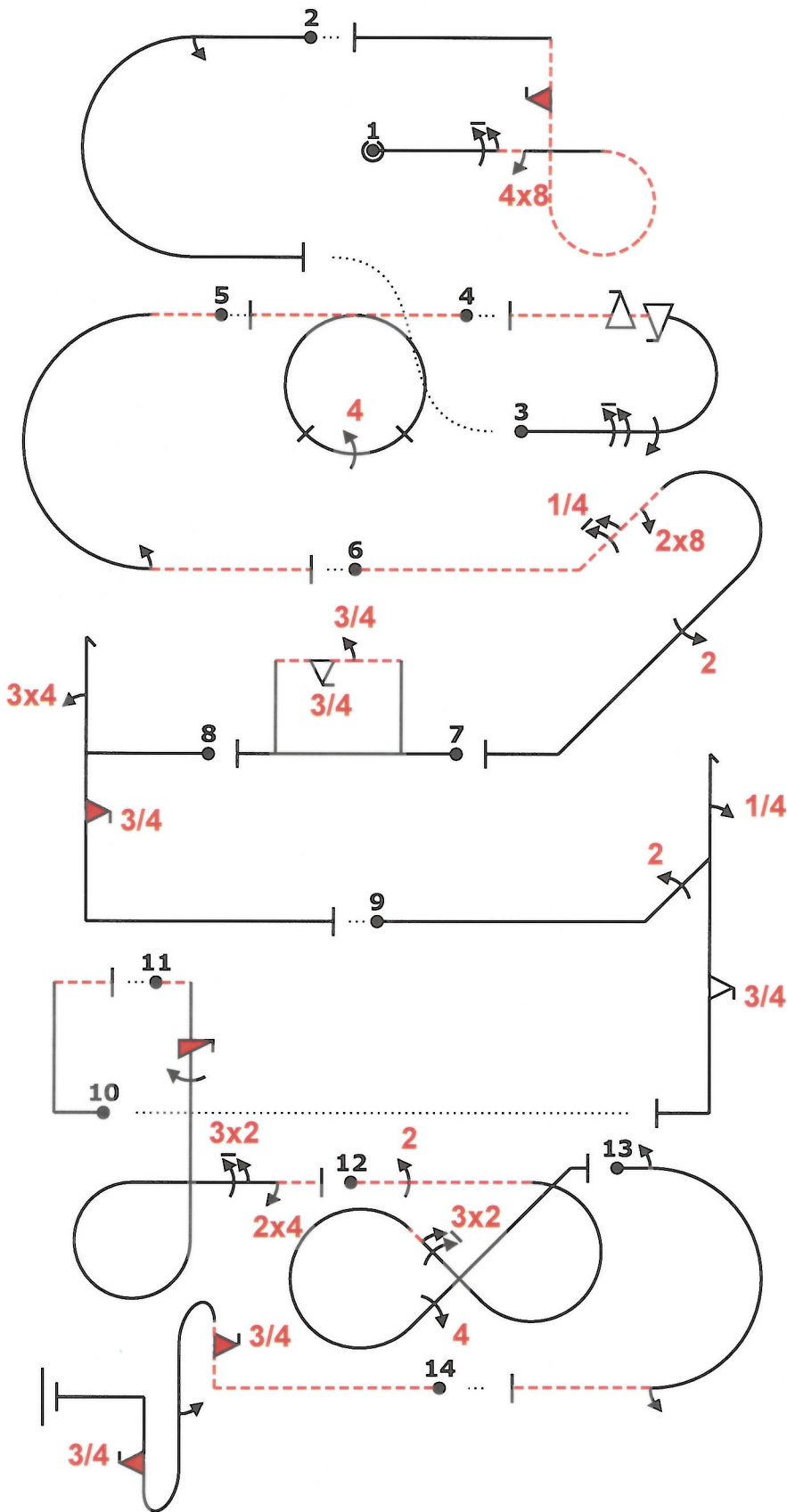

Proposal "H" CZE
 Pilot
 A/C

← wind/vent



Power		
Fig	Aresti	K
1 F	8.6.5.3	16
	9.1.3.6	10
	9.8.3.2	7
	9.10.1.2	17
2 Add.	7.2.3.3	6
	9.1.3.2	4
3 A	7.2.1.1	6
	9.1.3.8	12
	9.1.3.4	8
	9.9.3.4	11
	9.9.8.4	13
4 G	7.4.1.4	11
	9.4.3.4	11
5 Add.	7.2.2.4	7
	9.1.3.2	4
6 I	8.4.17.2	11
	9.1.2.5	11
	9.8.2.1	5
	9.2.4.4	9
7 E	7.4.3.1	14
	9.9.8.3	13
	9.1.3.3	6
8 C	5.2.1.1	17
	9.4.1.3	12
	9.10.5.3	13
9 D	5.3.1.1	18
	9.2.2.4	11
	9.1.1.1	6
	9.9.5.3	11
10 Add.	1.1.7.1	9
11 H	8.6.1.4	12
	9.12.1.4	7
	9.1.5.4	8
	9.2.3.6	12
	9.4.3.2	5
12 J	7.8.3.4	19
	9.2.3.4	9
	9.2.2.6	14
	9.4.2.4	13
13 Add.	7.2.4.3	6
	9.1.3.2	4
	9.1.3.2	4
14 B	8.8.7.2	21
	9.10.1.3	17
	9.1.5.2	4
	9.10.6.3	19
Total K = 463		

Verified
Jury Pres.
21.8.24
8.15



Proposal "I" SUI
Pilot
A/C

← wind/vent

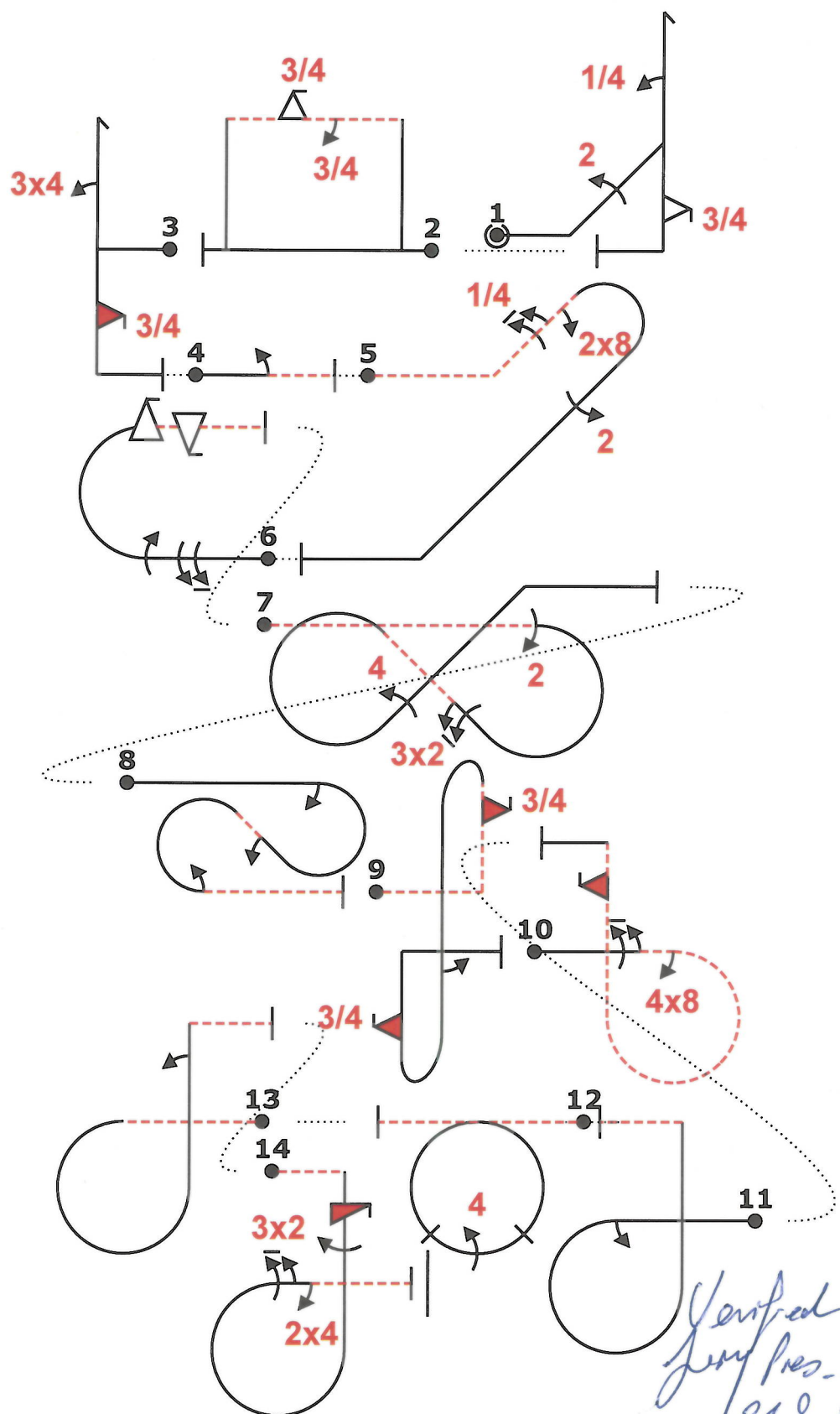

Power			
Fig	Aresti	K	
1 D	5.3.1.1	18	46
	9.2.2.4	11	
	9.1.1.1	6	
	9.9.5.3	11	
2 E	7.4.3.1	14	33
	9.9.8.3	13	
	9.1.3.3	6	
3 C	5.2.1.1	17	42
	9.4.1.3	12	
	9.10.5.3	13	
4 Add.	1.1.1.3	2	6
	9.1.3.2	4	
5 I	8.4.17.2	11	36
	9.1.2.5	11	
	9.8.2.1	5	
	9.2.4.4	9	
6 A	7.2.1.1	6	50
	9.1.3.8	12	
	9.1.3.4	8	
	9.9.3.4	11	
	9.9.8.4	13	
7 J	7.8.3.4	19	55
	9.2.3.4	9	
	9.2.2.6	14	
	9.4.2.4	13	
8 Add.	7.5.8.3	15	6
	9.1.3.2	4	
	9.1.2.2	6	
	9.1.3.2	4	
9 B	8.8.7.2	21	61
	9.10.1.3	17	
	9.1.5.2	4	
	9.10.6.3	19	
10 F	8.6.5.3	16	50
	9.1.3.6	10	
	9.8.3.2	7	
	9.10.1.2	17	
11 Add.	8.6.7.3	12	6
	9.1.3.2	4	
12 G	7.4.1.4	11	22
	9.4.3.4	11	
13 Add.	8.6.5.4	12	6
	9.1.1.2	8	
14 H	8.6.1.4	12	44
	9.12.1.4	7	
	9.1.5.4	8	
	9.2.3.6	12	
	9.4.3.2	5	
Total K = 463			

*Verified
by Pres.
21.8.24*

8:15



Proposal "J" LTU
Pilot
A/C

Mokre/Zamość, POLAND 15-25 Aug. 24		Form B
Pilot ID	CIVA Unlimited Programme4	
	Flight #	

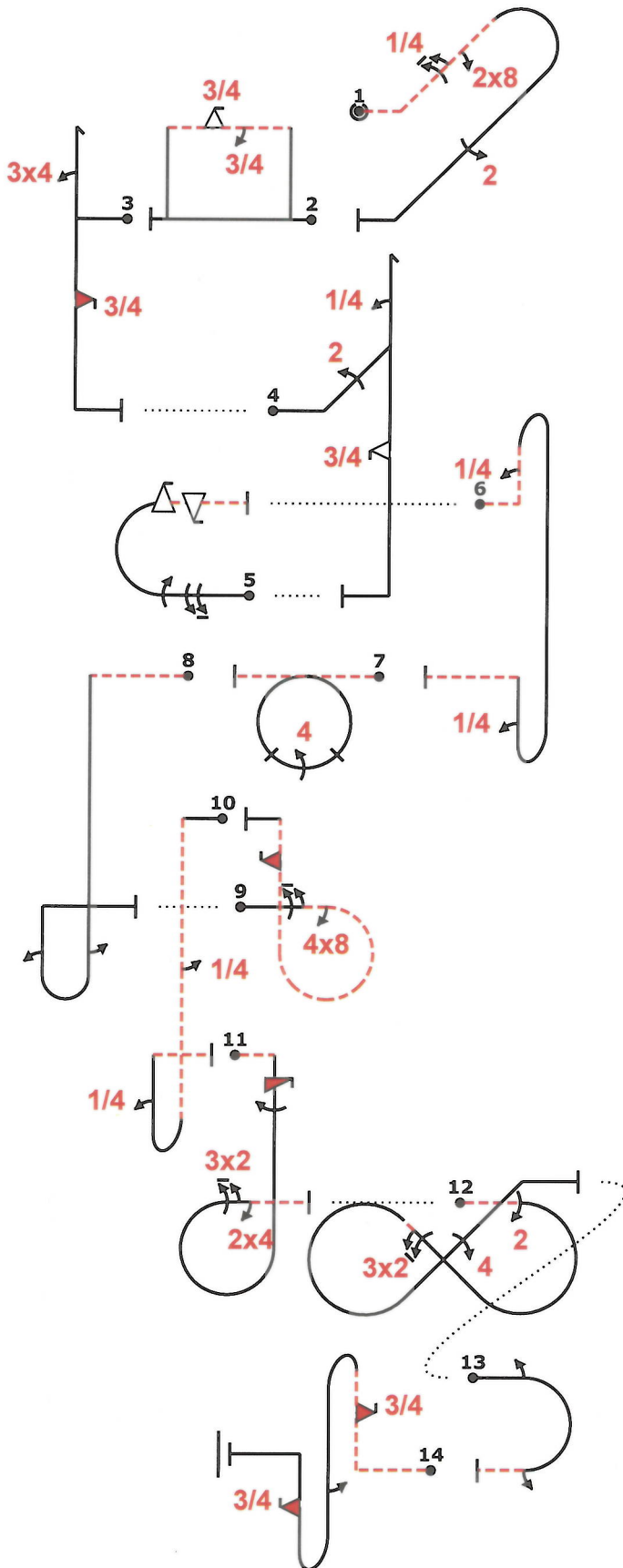

Power			
Fig	Aresti	K	
1	8.4.17.2	11	36
	9.1.2.5	11	
	9.8.2.1	5	
	9.2.4.4	9	
2	7.4.3.1	14	33
	9.9.8.3	13	
	9.1.3.3	6	
3	5.2.1.1	17	42
	9.4.1.3	12	
	9.10.5.3	13	
4	5.3.1.1	18	46
	9.2.2.4	11	
	9.1.1.1	6	
	9.9.5.3	11	
5	7.2.1.1	6	50
	9.1.3.8	12	
	9.1.3.4	8	
	9.9.3.4	11	
	9.9.8.4	13	
6	8.8.8.2	20	6
	9.1.1.1	6	
	9.1.1.1	6	
7	7.4.1.4	11	22
	9.4.3.4	11	
8	8.4.2.4	14	6
	9.1.5.2	4	
	9.1.1.2	8	
9	8.6.5.3	16	50
	9.1.3.6	10	
	9.8.3.2	7	
	9.10.1.2	17	
10	8.4.4.3	14	6
	9.1.5.1	2	
	9.1.1.1	6	
11	8.6.1.4	12	44
	9.12.1.4	7	
	9.1.5.4	8	
	9.2.3.6	12	
	9.4.3.2	5	
12	7.8.3.4	19	55
	9.2.3.4	9	
	9.2.2.6	14	
	9.4.2.4	13	
13	7.2.4.3	6	6
	9.1.3.2	4	
	9.1.3.2	4	
14	8.8.7.2	21	61
	9.10.1.3	17	
	9.1.5.2	4	
	9.10.6.3	19	
Total K = 463			

K

Verified
 Jey Pres.
 21.8.24
 8:20

Proposal "K" FRA
 Pilot
 A/C

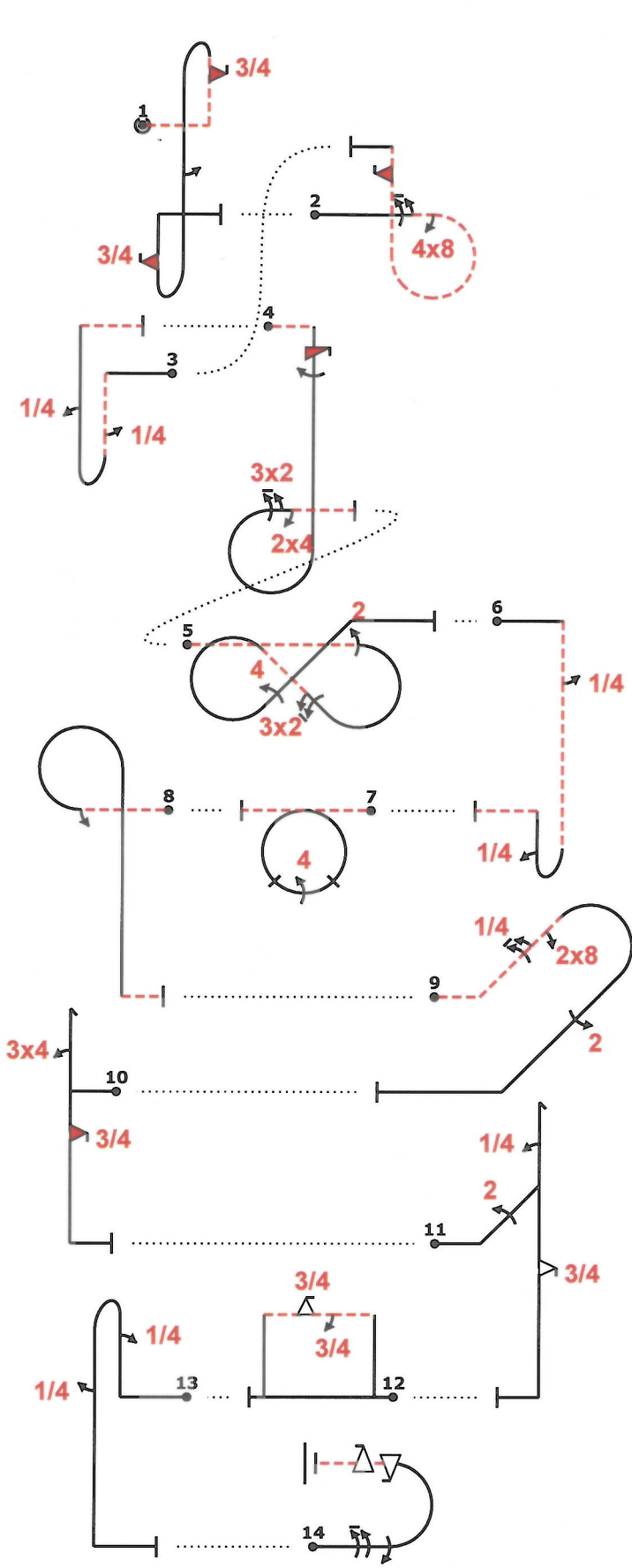

← wind/vent

Power			
Fig	Aresti	K	
1	8.8.7.2	21	61
	9.10.1.3	17	
	9.1.5.2	4	
	9.10.6.3	19	
2	8.6.5.3	16	50
	9.1.3.6	10	
	9.8.3.2	7	
	9.10.1.2	17	
3	8.4.4.3	14	6
	9.1.5.1	2	
	9.1.1.1	6	
4	8.6.1.4	12	44
	9.12.1.4	7	
	9.1.5.4	8	
	9.2.3.6	12	
	9.4.3.2	5	
5	7.8.3.4	19	55
	9.2.3.4	9	
	9.2.2.6	14	
	9.4.2.4	13	
6	8.4.4.3	14	6
	9.1.5.1	2	
	9.1.1.1	6	
7	7.4.1.4	11	22
	9.4.3.4	11	
8	8.6.8.2	13	6
	9.1.3.2	4	
9	8.4.17.2	11	36
	9.1.2.5	11	
	9.8.2.1	5	
	9.2.4.4	9	
10	5.2.1.1	17	42
	9.4.1.3	12	
	9.10.5.3	13	
11	5.3.1.1	18	46
	9.2.2.4	11	
	9.1.1.1	6	
	9.9.5.3	11	
12	7.4.3.1	14	33
	9.9.8.3	13	
	9.1.3.3	6	
13	8.4.1.1	13	6
	9.1.1.1	6	
	9.1.5.1	2	
14	7.2.1.1	6	50
	9.1.3.8	12	
	9.1.3.4	8	
	9.9.3.4	11	
	9.9.8.4	13	
Total K = 463			

Checked
 Jerry Pres.
 21.8.24
 8:20

Proposal "L" FRA Pilot
 A/C

Mokre/Zamość, POLAND 15-25 Aug. 24		Form B
Pilot ID	CIVA Unlimited Programme4	
	Flight #	

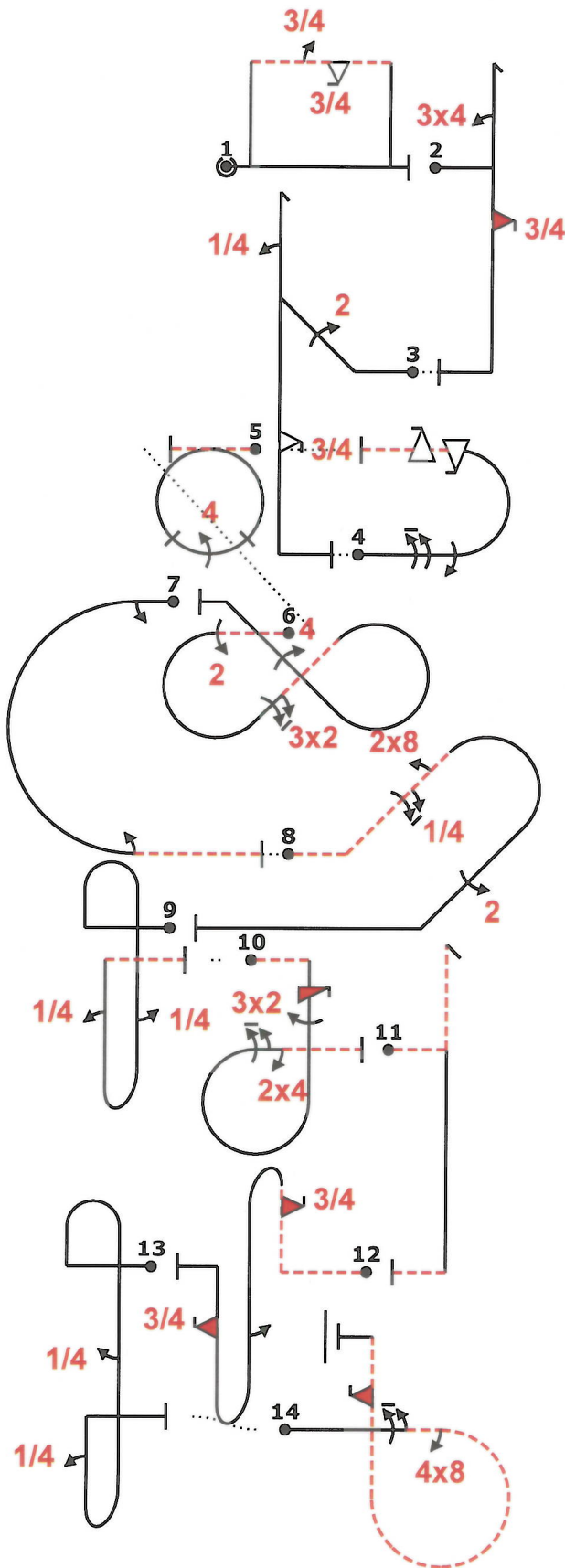

Power			
Fig	Aresti	K	
1 E	7.4.3.1	14	33
	9.9.8.3	13	
	9.1.3.3	6	
2 C	5.2.1.1	17	42
	9.4.1.3	12	
	9.10.5.3	13	
3 D	5.3.1.1	18	46
	9.2.2.4	11	
	9.1.1.1	6	
	9.9.5.3	11	
4 A	7.2.1.1	6	50
	9.1.3.8	12	
	9.1.3.4	8	
	9.9.3.4	11	
	9.9.8.4	13	
5 G	7.4.1.4	11	22
	9.4.3.4	11	
6 J	7.8.3.4	19	55
	9.2.3.4	9	
	9.2.2.6	14	
	9.4.2.4	13	
7 Add.	7.2.4.3	6	6
	9.1.3.2	4	
	9.1.3.2	4	
8 I	8.4.17.2	11	36
	9.1.2.5	11	
	9.8.2.1	5	
	9.2.4.4	9	
9 Add.	8.8.1.1	18	6
	9.1.5.1	2	
	9.1.1.1	6	
10 H	8.6.1.4	12	44
	9.12.1.4	7	
	9.1.5.4	8	
	9.2.3.6	12	
	9.4.3.2	5	
11 Add.	5.2.1.2	23	6
12 B	8.8.7.2	21	61
	9.10.1.3	17	
	9.1.5.2	4	
	9.10.6.3	19	
13 Add.	8.8.2.1	19	6
	9.1.5.1	2	
	9.1.1.1	6	
14 F	8.6.5.3	16	50
	9.1.3.6	10	
	9.8.3.2	7	
	9.10.1.2	17	
Total K = 463			

Verified
 Jury President
 21.8.24
 S. K.

Proposal "M" CZE
 Pilot
 A/C